

Technical Information

Liquiphant FTL31

Vibronic

Point level switch for liquids



Application

The Liquiphant FTL31 is a point level switch for liquids and is used in tanks, vessels and pipes.

It is used for overflow prevention or pump protection in cleaning and filter systems as well as in cooling and lubrication vessels, for instance.

Ideal for applications in which float switches or conductive, capacitance and optical sensors have been used up to now. The Liquiphant FTL31 also works in areas where these measuring principles are not suitable due to conductivity, buildup, turbulence, flow conditions or air bubbles.

The Liquiphant FTL31 can be used for process temperatures up to:

- 100 °C (212 °F)
- 150 °C (302 °F)

Not suitable for hazardous areas.

The use of the Liquiphant FTL33 is recommended for hygiene areas.

Your benefits

- Operational safety, reliability and universal application thanks to the tuning fork measuring principle
- Robust stainless steel housing (316L)
- External function test with test magnet
- Onsite function check possible thanks to LED indication
- Compact design for easy installation even in confined conditions or hard-to-access areas





Table of contents

Document information	3	Process	17
Document conventions	3	Process temperature range	17
Function and system design	4	Process pressure range	17
Measuring principle	4	Density	17
Measuring system	4	State of aggregation	17
Input	5	Viscosity	17
Measured variable	5	Solids contents	17
Measuring range	5	Lateral loading capacity	17
Output	5	Mechanical construction	18
Switch output	5	Design	18
Operating modes	5	Connector	19
Power supply	5	Tuning fork	19
Supply voltage	5	Sensor type	20
Power consumption	5	Weight	23
Current consumption	5	Materials	23
Residual ripple	5	Surface roughness	24
Electrical connection	5	Operability	25
Cable entry	9	LED display	25
Cable specification	10	Function test with test magnet	25
Overvoltage protection	10	Certificates and approvals	26
Performance characteristics	11	CE mark	26
Reference operating conditions	11	EAC conformity	26
Switch point	11	RCM-Tick marking	26
Hysteresis	11	Approval	26
Non-repeatability	11	Overfill prevention	26
Influence of ambient temperature	11	Marine approvals	26
Influence of medium temperature	11	CRN approval	26
Influence of medium pressure	11	Inspection certificates	26
Switching delay	11	Manufacturer declarations	26
Switch-on delay	11	Pressure Equipment Directive	26
Measuring frequency	11	Other standards and guidelines	26
Measured error	11	Ordering information	27
Installation	12	Ordering information	27
Orientation	12	Services (optional)	27
Installation instructions	12	Accessories	27
Length of connecting cable	14	Weld-in adapter	27
Environment	15	Plug-in jack, cable	27
Ambient temperature range	15	Additional accessories	28
Storage temperature	15	Supplementary documentation	29
Climate class	15	Operating Instructions	29
Altitude	15	Additional documentation	29
Degree of protection	16	Certificates	29
Shock resistance	16		
Vibration resistance	16		
Electromagnetic compatibility	16		
Reverse polarity protection	16		
Short-circuit protection	16		



Document information

Document conventions





Safety symbols

Symbol	Meaning
 <small>A0011189-EN</small>	DANGER! This symbol alerts you to a dangerous situation. Failure to avoid this situation will result in serious or fatal injury.
 <small>A0011190-EN</small>	WARNING! This symbol alerts you to a dangerous situation. Failure to avoid this situation can result in serious or fatal injury.
 <small>A0011191-EN</small>	CAUTION! This symbol alerts you to a dangerous situation. Failure to avoid this situation can result in minor or medium injury.
 <small>A0011192-EN</small>	NOTE! This symbol contains information on procedures and other facts which do not result in personal injury.

Electrical symbols

Symbol	Meaning
 <small>A0011200</small>	Ground connection A grounded terminal which, as far as the operator is concerned, is grounded via a grounding system.
 <small>A0011199</small>	Protective ground connection A terminal which must be connected to ground prior to establishing any other connections.

Symbols for certain types of information

Symbol	Meaning
 <small>A0011182</small>	Permitted Indicates procedures, processes or actions that are permitted.
 <small>A0011184</small>	Forbidden Indicates procedures, processes or actions that are forbidden.
 <small>A0011193</small>	Tip Indicates additional information.
 <small>A0011194</small>	Reference to documentation Refers to the corresponding device documentation.
 <small>A0011195</small>	Reference to page Refers to the corresponding page number.

Symbols in graphics

Symbol	Meaning
1, 2, 3 ...	Item numbers
A, B, C, ...	Views

Function and system design

Measuring principle

A piezoelectric drive causes the tuning fork of the Liquiphant FTL31 to vibrate at its resonance frequency. When the tuning fork is immersed in a liquid, its intrinsic frequency changes due to the change in density of the surrounding medium. The electronics system in the point level switch monitors the resonance frequency and indicates whether the tuning fork is vibrating in air or is covered by liquid.

A signal is output via the DC-PNP or AC/DC electrical connection.

Measuring system

The measuring system consists of a Liquiphant FTL31 point level switch, e.g. for connection to programmable logic controllers (PLC), a mini-contactor or solenoid valve.

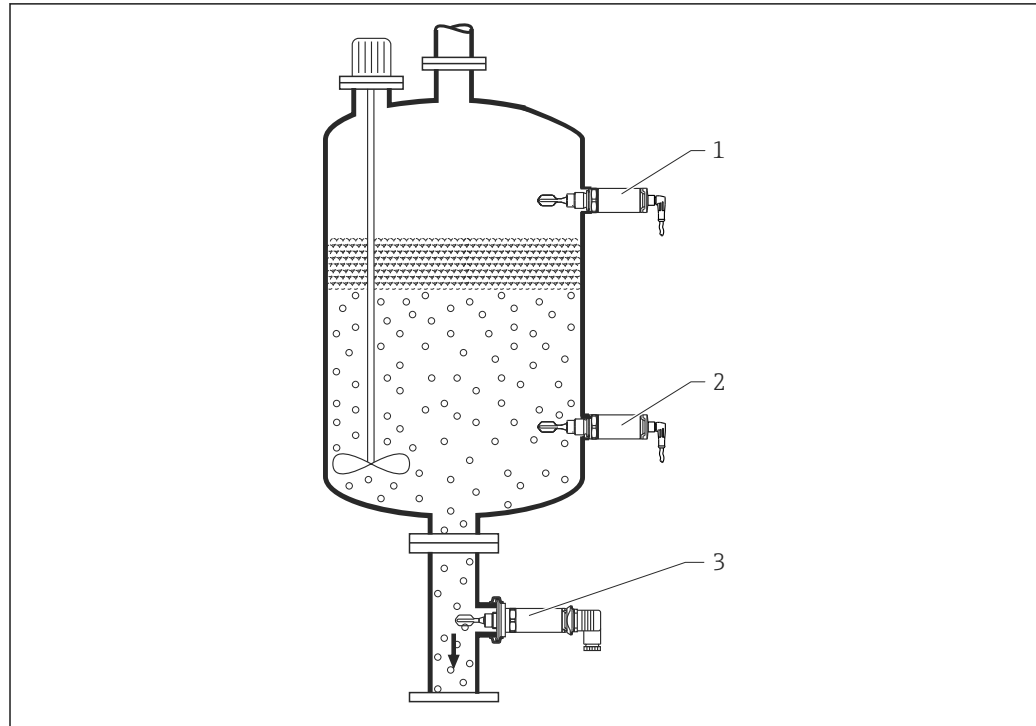

A0020911

- 1 Overfill prevention or upper level detection MAX (maximum safety)
- 2 Lower level detection MIN (minimum safety)
- 3 Lower level detection MIN, e.g. dry running protection for pump

Input

Measured variable	Density
Measuring range	> 0.7 g/cm ³ (optionally available: > 0.5 g/cm ³)

Output



Switch output	<p>Switching behavior: On/Off</p> <p>Function 3-wire DC-PNP: Positive voltage signal at the switch output of the electronics (PNP), switching capacity 200 mA 2-wire AC/DC: Load switching in the power supply line, switching capacity 250 mA</p>
Operating modes	<p>The device has two operating modes: maximum safety (MAX) and minimum safety (MIN).</p> <p>By choosing the corresponding operating mode, the user ensures that the device also switches in a safety-oriented manner even in an alarm condition, e.g. if the power supply line is disconnected.</p> <ul style="list-style-type: none"> ▪ Maximum safety (MAX) The device keeps the electronic switch closed as long as the liquid level is below the fork. Sample application: overflow prevention ▪ Minimum safety (MIN) The device keeps the electronic switch closed as long as the fork is immersed in liquid. Sample application: Dry running protection for pumps <p>The electronic switch opens if the limit is reached, if a fault occurs or the power fails (quiescent current principle).</p>



Power supply

Supply voltage	DC-PNP: 10 to 30 V DC, 3-wire AC/DC: 20 to 253 V AC/DC, 2-wire
Power consumption	DC-PNP: < 975 mW AC/DC: < 850 mW
Current consumption	DC-PNP: < 15 mA AC/DC: < 3.8 mA
Residual ripple	DC-PNP: 5 Vss 0 to 400 Hz AC/DC: –
Electrical connection	<p>Two electronic versions and three different connections are available for the device.</p> <ul style="list-style-type: none"> ▪ Electronic version 3-wire DC-PNP with connection; M12 plug, valve plug or cable ▪ Electronic version 2-wire AC/DC with connection; valve plug or cable <p>A fine-wire fuse is necessary for operation: 500 mA slow-blow.</p> <p>Electronic version 3-wire DC-PNP</p> <p>3-wire DC-PNP is preferably used in conjunction with programmable logic controllers (PLC), DI modules as per EN 61131-2. Positive signal at the switch output of the electronics (PNP).</p> <p>Voltage source: non-hazardous contact voltage or Class 2 circuit (North America).</p>

Connection with M12 plug

Depending on the analysis of the switch outputs, the device works in the MAX (maximum safety) or MIN (minimum safety) mode.

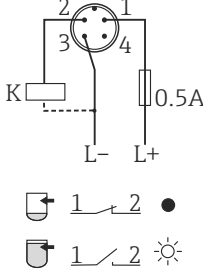
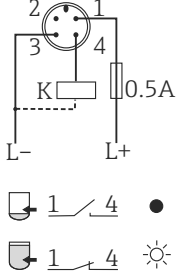





 A cable is optionally available for order, see "Accessories" section →  27.

3-wire DC-PNP	Operating mode	
 <p>A0022901</p>	MAX	MIN
		
Symbols Description  Yellow LED (ye) lit  Yellow LED (ye) not lit K external load		

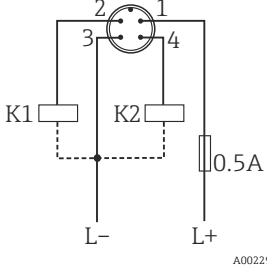
Function monitoring with M12 connector







Using a two-channel analysis, function monitoring of the sensor can be implemented in addition to level monitoring, e.g. per relay switch, PLC, AS-i Bus I/O module, ...).

When both outputs are connected, the MIN and MAX outputs assume opposite states when the device is operating fault-free (XOR). In the event of an alarm condition or a line break, both outputs are deenergized.

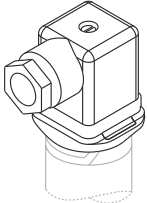
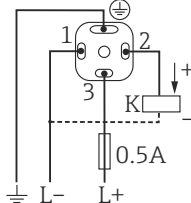
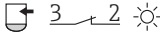
Connection with 3-wire DC-PNP for function monitoring based on XOR logic	Yellow LED (ye)	Red LED (rd)
 <p>A0022917</p>	Sensor covered	
	Sensor exposed	
	Fault	
Symbols Description  LED lit  LED not lit  Fault or warning K1 / K2 external load		

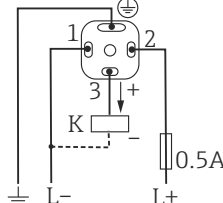
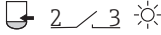
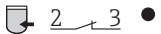
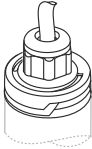
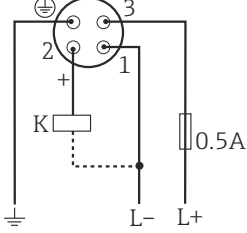
Connection with valve plug or cable

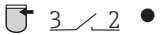
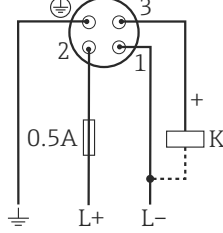
Depending on the assignment of the connector or the wiring of the cable, the device works in either the MAX or MIN operating mode.

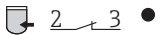
3-wire DC-PNP	Operating mode									
<p>Valve plug</p>  <p>A0022900</p>	<p>MAX</p>  <p>   </p>	<p>MIN</p>  <p>   </p>								
<p>Cable (cannot be dismantled)</p>  <p>A0022902</p> <p>Core colors: 1 = BK (black) 2 = GR (gray) 3 = BN (brown) Ground = GNYE (green-yellow)</p>	 <p>   </p>	 <p>   </p>								
<table border="0"> <thead> <tr> <th style="text-align: left;">Symbols</th> <th style="text-align: left;">Description</th> </tr> </thead> <tbody> <tr> <td style="text-align: center;">☀</td> <td>Yellow LED (ye) lit</td> </tr> <tr> <td style="text-align: center;">•</td> <td>Yellow LED (ye) not lit</td> </tr> <tr> <td style="text-align: center;">K</td> <td>external load</td> </tr> </tbody> </table>			Symbols	Description	☀	Yellow LED (ye) lit	•	Yellow LED (ye) not lit	K	external load
Symbols	Description									
☀	Yellow LED (ye) lit									
•	Yellow LED (ye) not lit									
K	external load									

Electronic version 2-wire AC/DC

The load is switched via an electronic switch directly in the power supply circuit. Always connect in series with a load!

Not suitable for connection to low-voltage PLC inputs!

Selection tool for relays

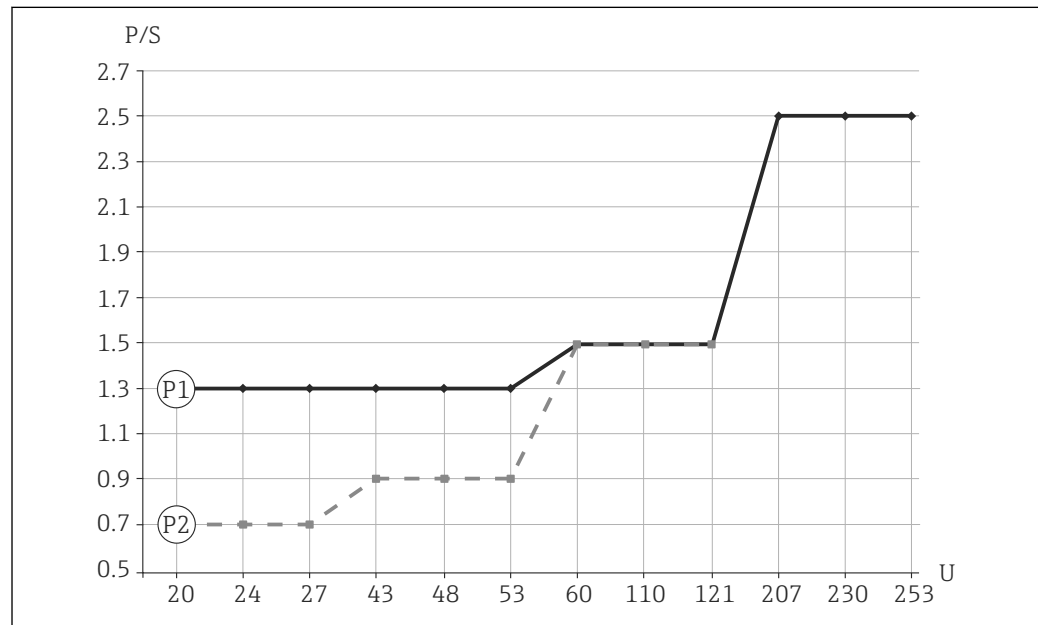

A0023486

1 Minimum rated power of the load

P/S Rated power in [W] / [VA]

U Operating voltage in [V]

Item	Supply voltage	Rated power	
		min	max
P1 AC mode	24 V	> 1.3 VA	< 6 VA
	110 V	> 1.5 VA	< 27.5 VA
	230 V	> 2.5 VA	< 57.5 VA
P2 DC mode	24 V	> 0.7 W	< 6 W
	48 V	> 0.9 W	< 12 W
	60 V	> 1.5 W	< 15 W

Relays with a lower rated power can be operated by means of an RC module connected in parallel (optional).

Connection with valve plug or cable

Depending on the assignment of the connector or the wiring of the cable, the device works in either the MAX or MIN operating mode.

When the cable is wired, one wire of the cable does not have any function in each of the operating modes (brown in the case of MIN, and gray in the case of MAX). The cable with no function must be secured against inadvertent contact.

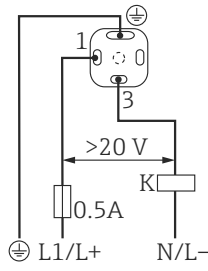
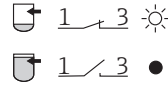
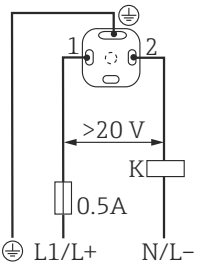
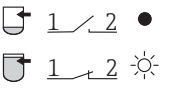
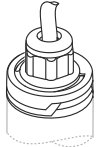
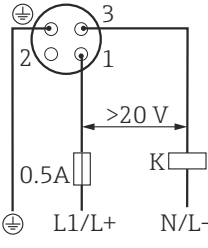
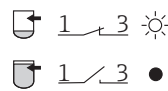
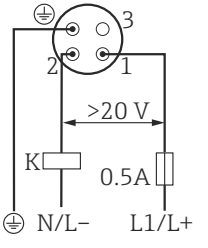
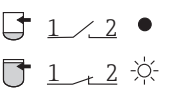
2-wire AC/DC	Operating mode	
	MAX	MIN
<p>Valve plug</p>  <p>A0022900</p>	 <p>A0021219</p>  <p>A0021418</p>	 <p>A0021220</p>  <p>A0021420</p>
<p>Cable (cannot be dismantled)</p>  <p>A0022902</p> <p>Core colors: 1 = BK (black) 2 = GR (gray) 3 = BN (brown) Ground = GNYE (green-yellow)</p>	 <p>A0022161</p>  <p>A0021418</p>	 <p>A0022225</p>  <p>A0021420</p>
<p>Symbols Description</p> <p>☼ Yellow LED (ye) lit</p> <p>• Yellow LED (ye) not lit</p> <p>K external load</p>		

Cable entry

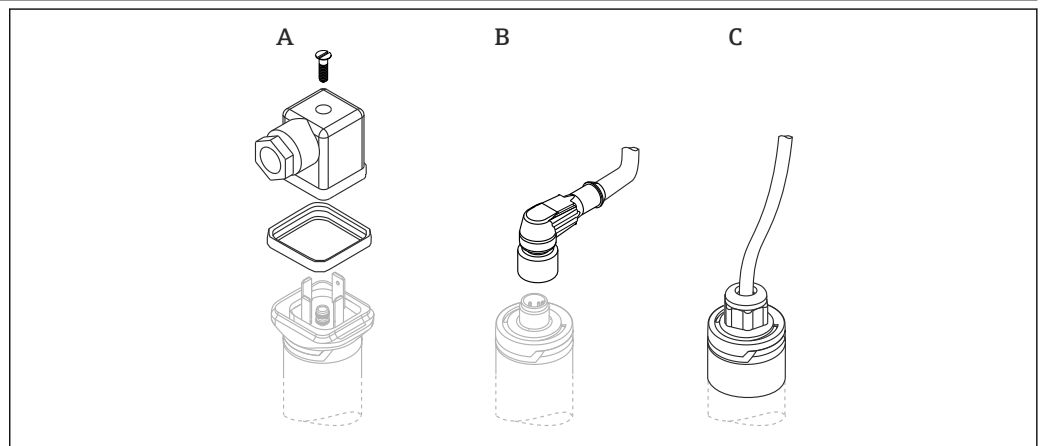

- A Valve plug (M16x1.5; NPT 1/2"; QUICKON)
- B M12 connector
- C Cable 5 m (16 ft); secured in place on delivery and cannot be disassembled

Cable specification

- Valve plug
 - Cable cross-section: max. 1.5 mm² (AWG 16)
 - Ø 3.5 to 8 mm (0.14 to 0.26 in)
 - M12 connector: IEC 60947-5-2
 - Cable (3LPE)
 - Cable cross-section: 0.75 mm² (AWG 20)
 - Ø 6 to 8 mm (0.24 to 0.31 in)
 - Material: PUR
-

Overvoltage protection

Overvoltage category II

Performance characteristics

Reference operating conditions	Ambient temperature:	+25 °C (+77 °F)
	Process pressure:	1 bar (14.5 psi)
	Fluid:	Water (density: approx. 1 g/cm ³ , viscosity 1 mm ² /s)
	Medium temperature:	25 °C (77 °F)
	Density setting:	> 0.7 g/cm ³
	Switching time delay:	Standard (0.5 s, 1 s)
Switch point	13 mm (0.51 in)±1 mm	
Hysteresis	max. 3 mm (0.12 in)	
Non-repeatability	±1 mm (0.04 in) in accordance with DIN 61298-2	
Influence of ambient temperature	Negligible	
Influence of medium temperature	-25 µm (984 µin)/°C	
Influence of medium pressure	-20 µm (787 µin)/bar	
Switching delay	<ul style="list-style-type: none"> ■ 0.5 s when tuning fork is covered ■ 1.0 s when tuning fork is uncovered ■ Optionally available: 0.2 s; 1.5 s or 5 s (when the tuning fork is covered and uncovered) 	
Switch-on delay	max. 3 s	
Measuring frequency	approx. 1 100 Hz in air	
Measured error	In event of device change: ±2 mm (0.08 in) as per DIN 61298-2	

Installation

Orientation

The point level switch can be installed in any position in a vessel, pipe or tank. Foam formation does not affect the function.

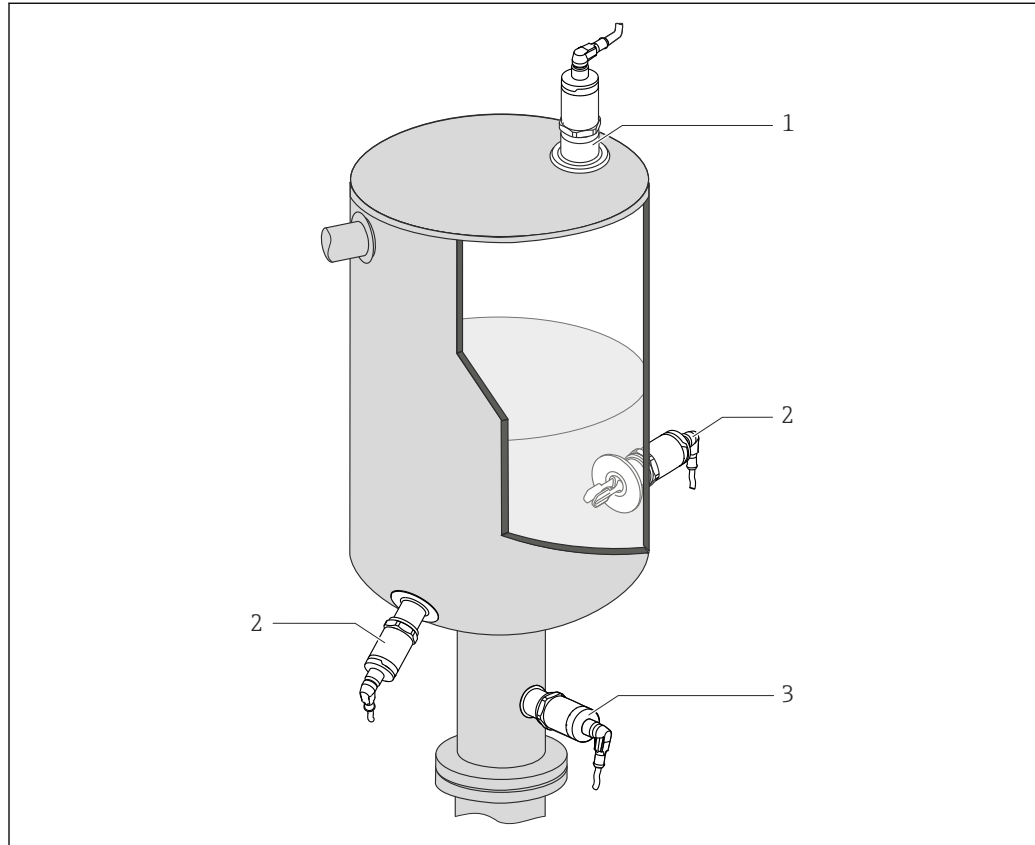

A0029118

2 Installation options

- 1 Overfill prevention or upper level detection
- 2 Lower level detection
- 3 Dry running protection for pump

Installation instructions

Switch point

The switch point (A) on the sensor depends on the orientation of the point level switch (water +25 °C (+77 °F), 1 bar (14.5 psi)).

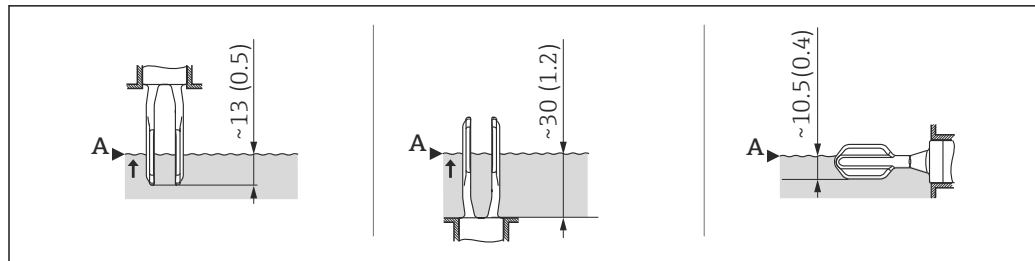

A0020734

3 Vertical and horizontal orientation, dimensions in mm (in)

Short tube version

The use of the short tube ensures that the switch point is at the same level as in the previous Liquiphant FTL260 model when an identical thread is selected. In this way, the device can be replaced quickly and easily. (Applies for process connections G 1" weld-in adapter for flush-mounted installation, MNPT 1" and R 1")

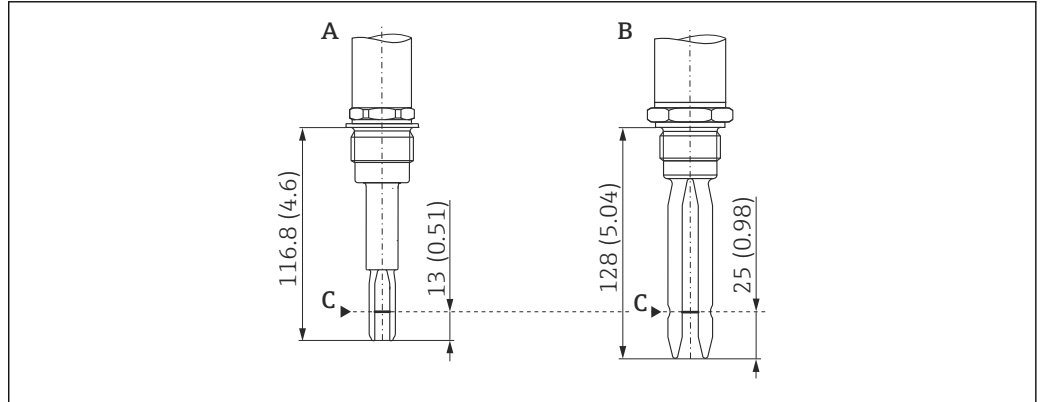

A0022122

- Dimensions mm (in)*
 A Liquiphant FTL31 with short tube
 B Liquiphant FTL260
 C Switch point

Installation in pipes

During installation, pay attention to the position of the fork in order to minimize turbulence in the pipe.

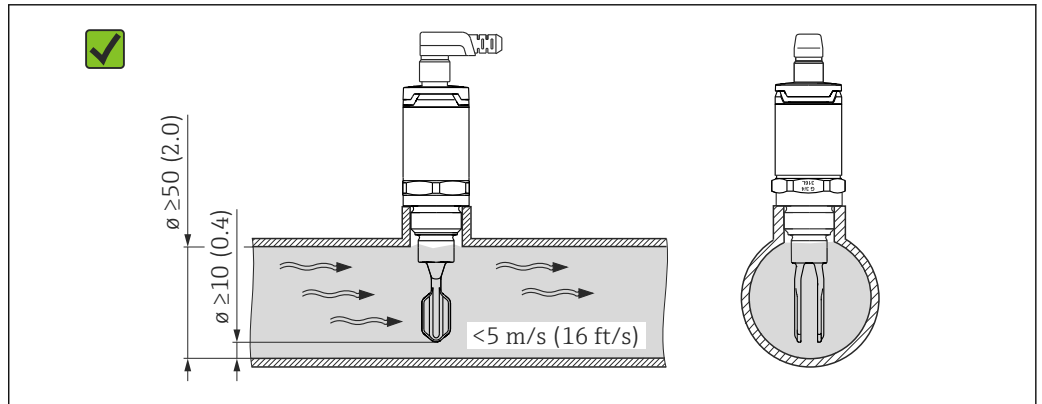

A0022357

Dimensions mm (in)

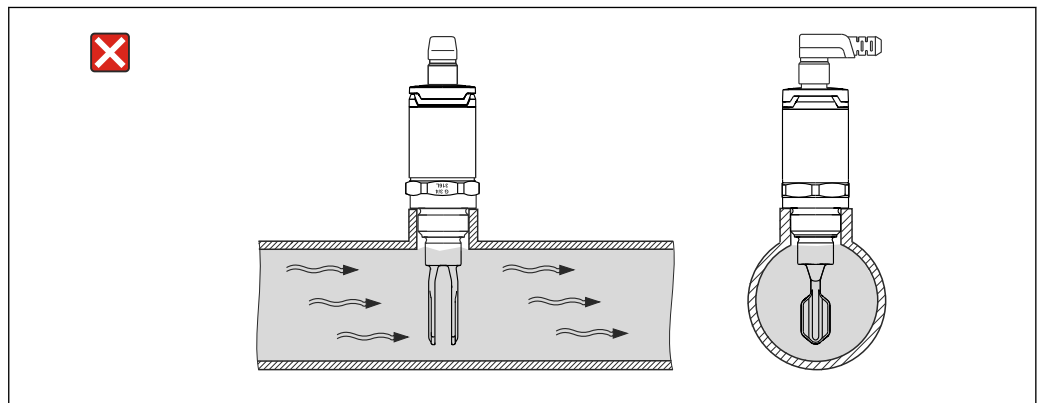

A0022268

Installation in vessels

If installed horizontally, pay attention to the position of the tuning fork to ensure that the liquid can drip off easily.

The electrical connection, e.g. M12 connector, should be pointing down with the cable. This can prevent moisture from penetrating.

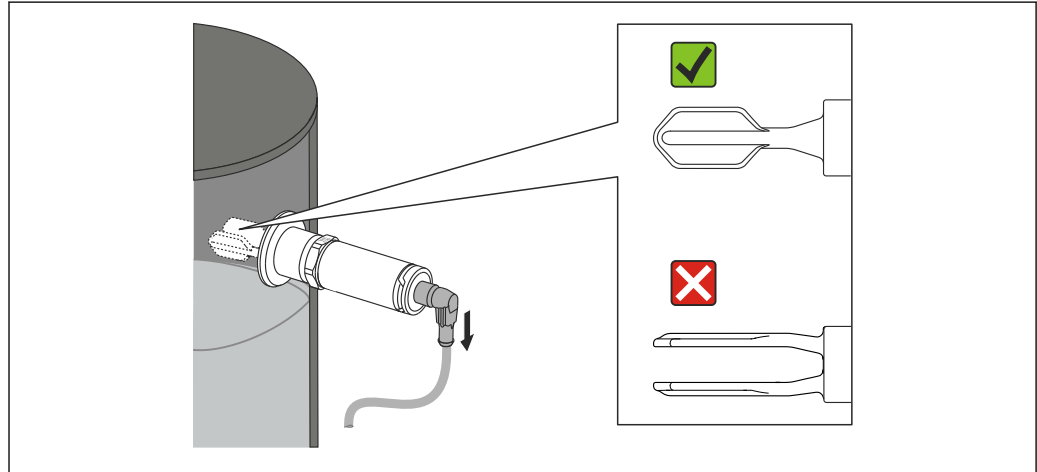

A0021034

4 Position of the fork in the case of horizontal installation in a vessel

Distance from wall

Ensure that there is sufficient distance between the expected buildup on the tank wall and the fork. Recommended distance from wall ≥ 10 mm (0.39 in).

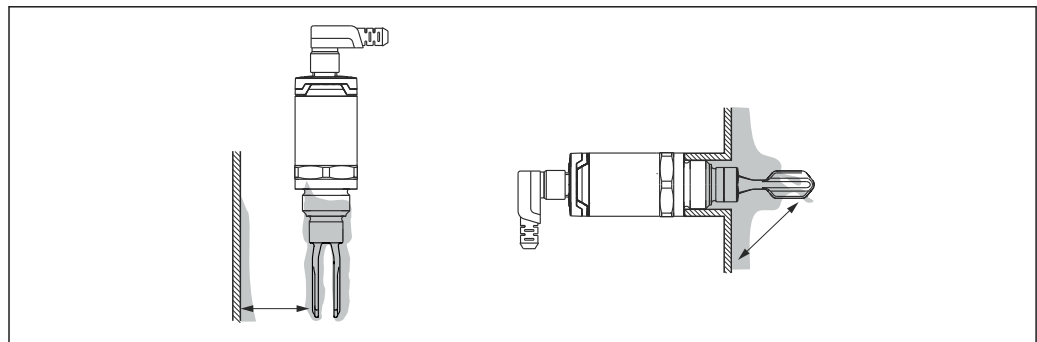

A0022272

Length of connecting cable

- to 1 000 m (3 281 ft)
- max. 25 Ω /wire, total capacitance < 100 nF

Environment

Ambient temperature range -40 to +70 °C (-40 to +158 °F)

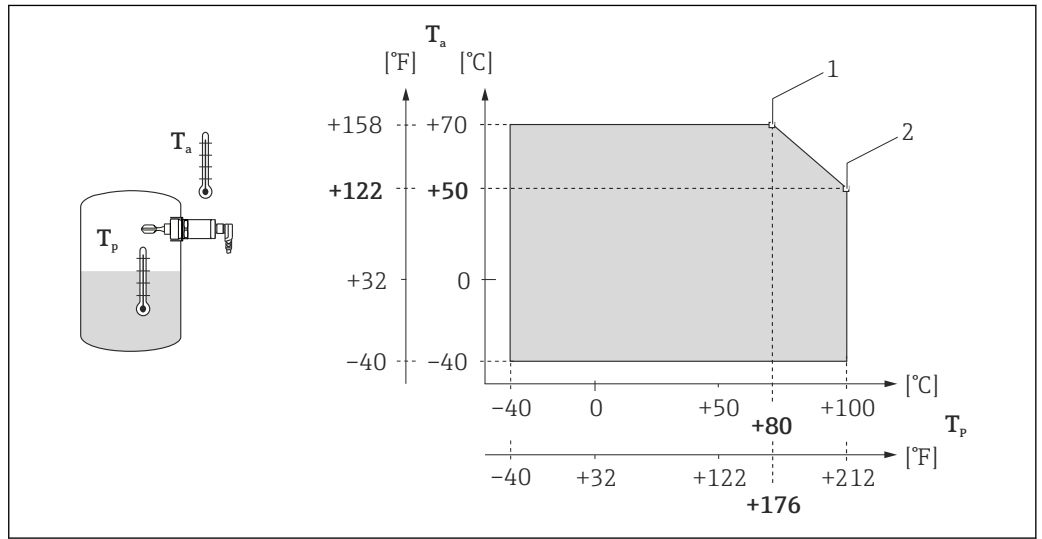

5 Derating curve: 100 °C (212 °F)

1 I_{max} : 200 mA (DC-PNP), 250 mA (AC/DC)

2 I_{max} : 150 mA (DC-PNP), 150 mA (AC/DC)

T_a Ambient temperature range

T_p Process temperature

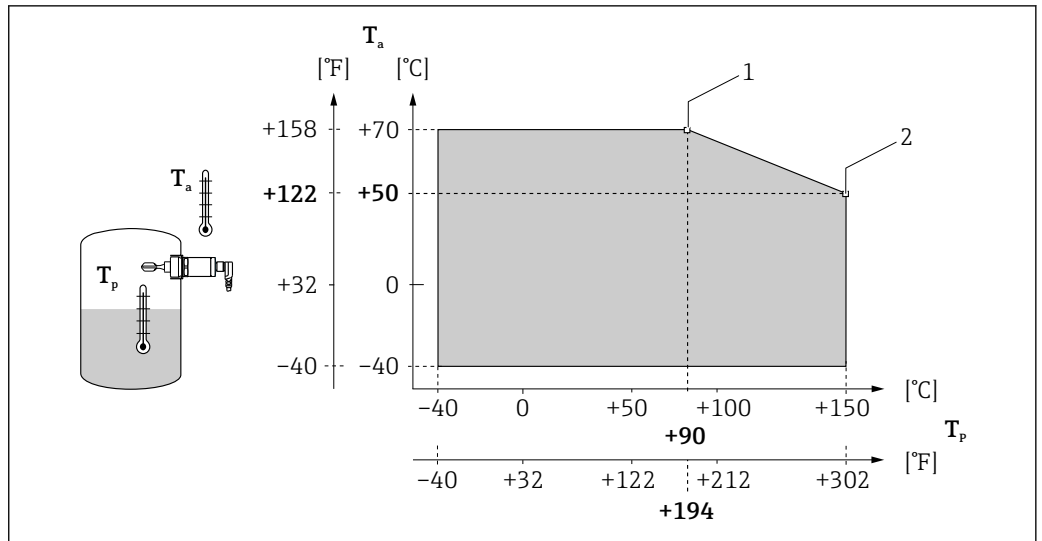

6 Derating curve: 150 °C (302 °F)

1 I_{max} : 200 mA (DC-PNP), 250 mA (AC/DC)

2 I_{max} : 150 mA (DC-PNP), 150 mA (AC/DC)

T_a Ambient temperature range

T_p Process temperature

Storage temperature -40 to +85 °C (-40 to +185 °F)

Climate class DIN EN 60068-2-38/IEC 68-2-38: test Z/AD

Altitude Up to 2 000 m (6 600 ft) above sea level

Degree of protection	<ul style="list-style-type: none">▪ IP65/67 NEMA Type 4X Enclosure (M12 connector)▪ IP65 NEMA Type 4X Enclosure (valve plug)▪ IP66/68 NEMA Type 4X/6P Enclosure (cable)
Shock resistance	a = 300 m/s ² = 30 g, 3 planes x 2 directions x 3 shocks x 18 ms, as per test Ea, prEN 60068-2-27:2007
Vibration resistance	a(RMS) = 50 m/s ² , ASD = 1.25 (m/s ²) ² /Hz, f = 5 to 2000 Hz, t = 3 x 2 h, as per test Fh, EN 60068-2-64:2008
Electromagnetic compatibility	Electromagnetic compatibility in accordance with all relevant requirements of the EN 61326 series and NAMUR recommendation EMC (NE21). For details, refer to the EC Declaration of Conformity. The EC Declaration of Conformity is available in the Download Area of the Endress+Hauser website: www.endress.com → Downloads.
Reverse polarity protection	2-wire AC/DC <ul style="list-style-type: none">▪ AC mode: the device has reverse polarity protection.▪ DC mode: in the event of reverse polarity the maximum safety mode is always detected. Check the wiring and perform a function check before commissioning. The device is not damaged in the event of reverse polarity. 3-wire DC-PNP Integrated. In the event of reverse polarity, the device is deactivated automatically.
Short-circuit protection	2-wire AC/DC During switching the sensor checks whether a load, e.g. relay or contactor, is present (load check). If an error occurs, the sensor is not damaged. Smart monitoring: normal operation is resumed once the error is fixed. 3-wire DC-PNP Overload protection/short-circuit protection at I > 250 mA; the sensor is not destroyed. Intelligent monitoring: Testing for overload at intervals of approx. 1.5 s; normal operation resumes once the overload/short-circuit has been rectified.

Process

Process temperature range	-40 to +100 °C (-40 to +212 °F) -40 to +150 °C (-40 to +302 °F)
Process pressure range	Max. -1 to +40 bar (-14.5 to +580 psi)
Density	> 0.7 g/cm ³ (optionally available: > 0.5 g/cm ³)
State of aggregation	Liquid
Viscosity	1 to 10 000 mPa·s, dynamic viscosity
Solids contents	ø < 5 mm (0.2 in)
Lateral loading capacity	Lateral loading capacity of the tuning fork: maximum 200 N

Mechanical construction

Design

Various versions of the point level switch are available, the features of which can be selected to suit your user needs.

The versions can be selected via the product structure in the Product Configurator, see the "Ordering information" section → [27](#). Examples can be seen in the following diagram:

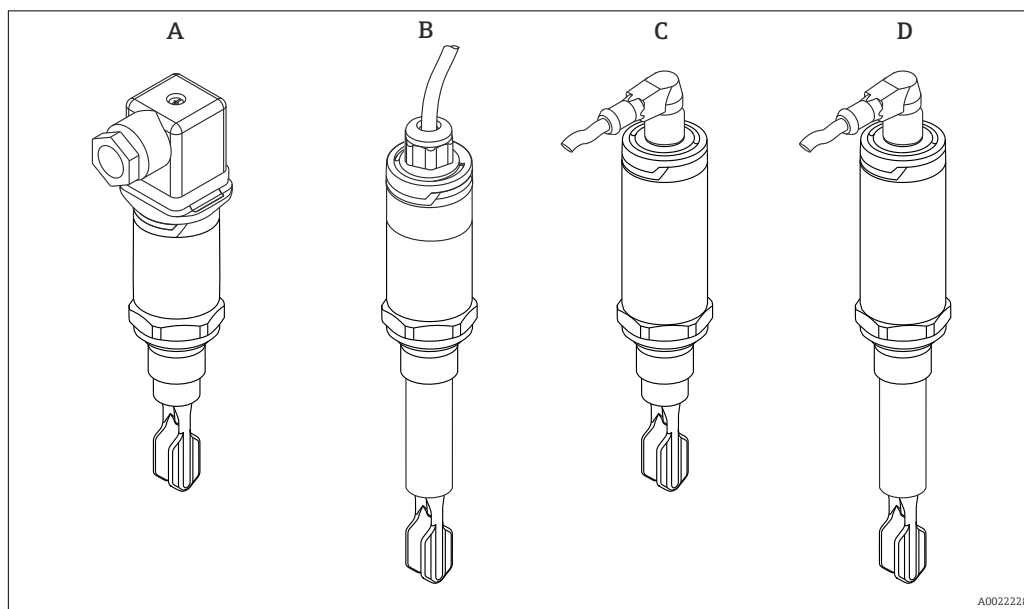

Versions	Examples			
	A	B	C	D
Electrical connection	Valve plug	Cable (cannot be dismantled)	M12 connector	M12 connector
Housing (sensor design) for process temperatures up to:	100 °C (212 °F)	100 °C (212 °F)	150 °C (302 °F)	150 °C (302 °F)
Sensor type	Compact version	Short tube version	Compact version	Short tube version

i Detailed information on the process connections is provided in the "Sensor type" section → [20](#).

i Information on the short tube version is provided in the "Installation instructions" section → [13](#).

Connector

Dimensions

Dimensions mm (in)

The following graphics illustrate the connectors together with the suitable housing covers on the housing of the point level switch.

Electrical connection with housing cover	Designation
	<p>A: Valve plug M16, NPT 1/2" for housing cover: PPSU plastic</p> <p>B: Valve plug QUICKON for housing cover: PPSU plastic</p>
	<p>M12 connector for housing cover: PPSU plastic (IP65/67)</p>
	<p>Captive cable with housing cover: PPSU plastic</p>

Tuning fork

Dimensions

Dimensions mm (in)

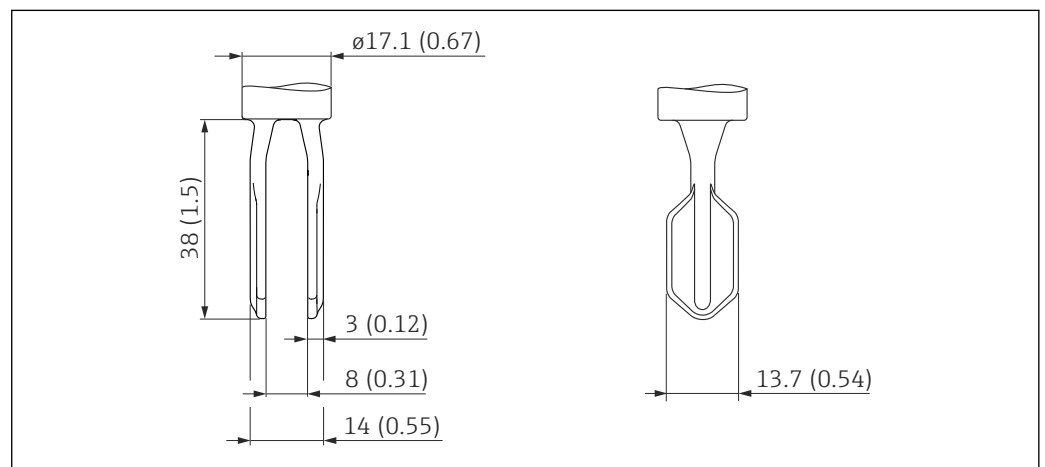

A0022250

Sensor type

Dimensions

Dimensions mm (in)

The total dimensions of the device can vary depending on the connector selected. To determine the total dimensions, please refer also to the "Electrical connection" section → 19.

Information on the following tables

- Meaning of symbols:





- * Dimension for process temperature max. 100 °C (212 °F)

- ** Dimension for process temperature max. 150 °C (302 °F)

- If several versions have the same dimensions, one example of the compact version and one example of the short tube version is given.

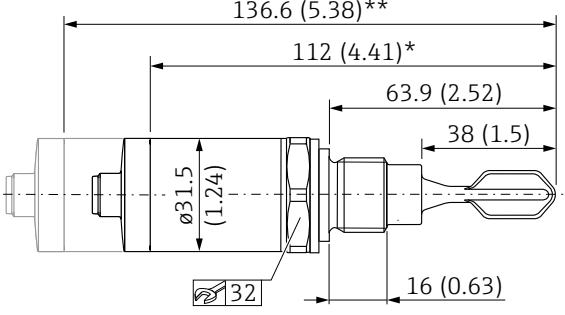
- The versions in the second column refer to the process connections in the product structure.

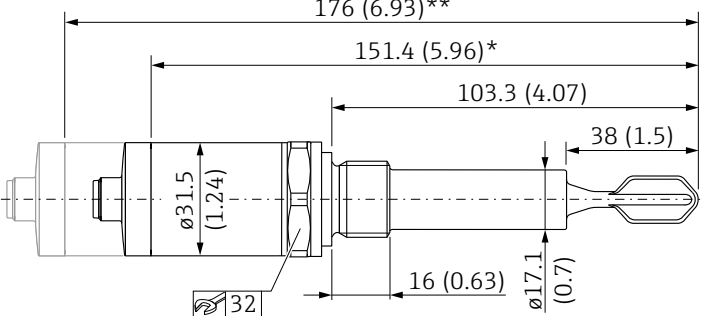
 Information on weld-in adapters can be found in the "Weld-in adapters, process adapters and flanges" documentation, TI00426F/00. → 29.



Dimensions	Version	Description
 <p> 7 Compact version, example G ½"</p>	<p>WBJ WCJ</p>	<p>Thread ISO 228 G ½" Thread ISO 228 G ¾"</p> <ul style="list-style-type: none"> ■ Material: 316L ■ Scope of delivery: flat seal (FA) ■ Pressure and temperature (maximum): +40 bar (+580 psi) at +150 °C (+302 °F) <p>W5J</p> <p>Thread ISO 228 G ¾" for flush-mounted installation in weld-in adapter</p> <ul style="list-style-type: none"> ■ Material: 316L ■ Scope of delivery: flat seal (FA) <p>Accessory: weld-in adapter</p> <ul style="list-style-type: none"> - Scope of delivery: seal (VMQ) - Pressure and temperature (maximum): +25 bar (+352 psi) at +150 °C (+302 °F) +40 bar (+580 psi) at +100 °C (+212 °F) <p>The dimensions apply for G ½", G ¾" and G ¾" for flush-mounted installation.</p>
 <p> 8 Short tube version, example G ½"</p>		

Dimensions	Version	Description
<p> 9 Compact version <small>A0022232</small> </p> <p> 10 Short tube version <small>A0022231</small> </p>	<p>WDJ</p>	<p>Thread ISO 228 G 1"</p> <ul style="list-style-type: none"> Material: 316L Scope of delivery: flat seal (FA) Pressure and temperature (maximum): +40 bar (+580 psi) at +150 °C (+302 °F)

Dimensions	Version	Description
<p> 11 Compact version <small>A0022008</small> </p> <p> 12 Short tube version <small>A0022007</small> </p>	<p>WSJ</p>	<p>Thread ISO 228 G 1" for flush-mounted installation in weld-in adapter</p> <ul style="list-style-type: none"> Material: 316L Scope of delivery: flat seal (FA) <p>Accessory: weld-in adapter</p> <ul style="list-style-type: none"> Scope of delivery: seal (VMQ) Pressure and temperature (maximum): +25 bar (+362 psi) at +150 °C (+302 °F) +40 bar (+580 psi) at +100 °C (+212 °F)

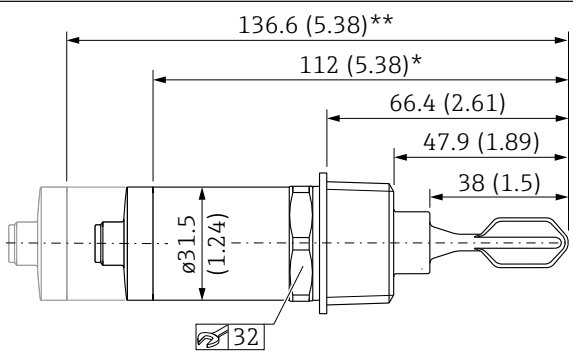
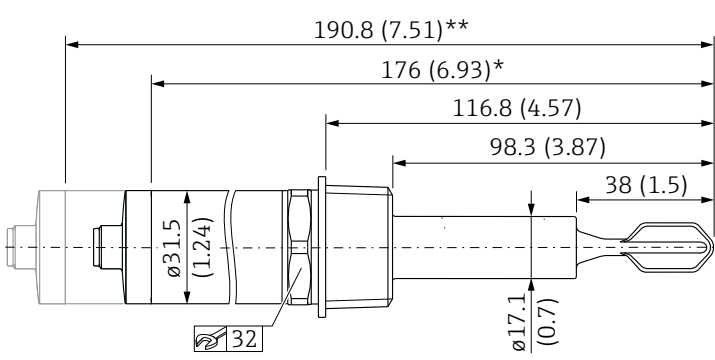
Dimensions	Version	Description
<p>136.6 (5.38)**</p> <p>112 (4.41)*</p> <p>63.9 (2.52)</p> <p>47.9 (1.89)</p> <p>38 (1.5)</p> <p>∅31.5 (1.24)</p> <p>32</p> <p>A0021788</p>	<p>VAJ</p> <p>VBJ</p> <p>XBJ</p> <p>XCJ</p>	<p>Thread ASME MNPT ½"</p> <p>Thread ASME MNPT ¾"</p> <p>Thread EN10226 R ½"</p> <p>Thread EN10226 R ¾"</p> <p>Pressure and temperature (maximum): +40 bar (+580 psi) at +150 °C (+302 °F)</p> <p>The dimensions apply for MNPT ½", MNPT ¾", R ½" and R ¾".</p>
<p>13 Compact version, example MNPT ¾"</p> <p>176 (6.93)**</p> <p>151.4 (5.96)*</p> <p>103.3 (4.07)</p> <p>87.3 (3.44)</p> <p>38 (1.5)</p> <p>∅31.5 (1.24)</p> <p>32</p> <p>∅17.1 (0.7)</p> <p>A0021895</p> <p>14 Short tube version, example MNPT ¾"</p>		

Dimensions	Version	Description
 <p>15 Compact version, example MNPT 1"</p>	VCJ	Thread ASME MNPT 1"
	XDJ	Thread EN10226 R 1" Pressure and temperature (maximum): +40 bar (+580 psi) at +150 °C (+302 °F) The dimensions apply for MNPT 1" and R 1".
 <p>16 Short tube version, example MNPT 1"</p>		

-  Pay attention to the temperature and pressure specifications for seals used at the customer site.
-  Endress+Hauser supplies DIN/EN process connections with threaded connection in stainless steel in accordance with AISI 316L (DIN/EN material number 1.4404 or 1.4435). With regard to their stability-temperature property, the materials 1.4404 and 1.4435 are grouped together under 13EO in EN 1092-1, Tab. 18. The chemical composition of the two materials can be identical.

Weight	Sensor type	Weight
	Compact version with process adapter G ½" and valve plug for process temperature up to 100 °C (212 °F)	Approx. 140 g (4.938 oz)
	Short tube version with process adapter G ½" and valve plug for process temperature up to 150 °C (302 °F)	Approx. 169 g (5.961 oz)

Materials Material specifications in accordance with AISI and DIN EN.

Materials in contact with process

Component part	Material
Tuning fork	316L
Process adapter	316L (1.4404/1.4435)
Short tube	316L (1.4404/1.4435)
Seal for weld-in adapter with G ¾", G 1"	VMQ
Flat seal	FA (composite material based on aramid fibers combined with NBR)

Materials not in contact with process

Component part	Material
Housing cover with M12 connector (IP65/67)	PPSU
Housing cover with valve plug (IP65)	
Housing cover with cable (IP66/68)	
Cable gland	PVDF
Design ring	PBT/PC
Housing	316L (1.4404/1.4435)
Nameplate	Plastic foil (attached to housing)

Surface roughness

Metallic surface in contact with process:

$R_a \leq 3.2 \mu\text{m}$ (126 μin)



The surface is not defined in the area of the welding seam.

Operability

LED display

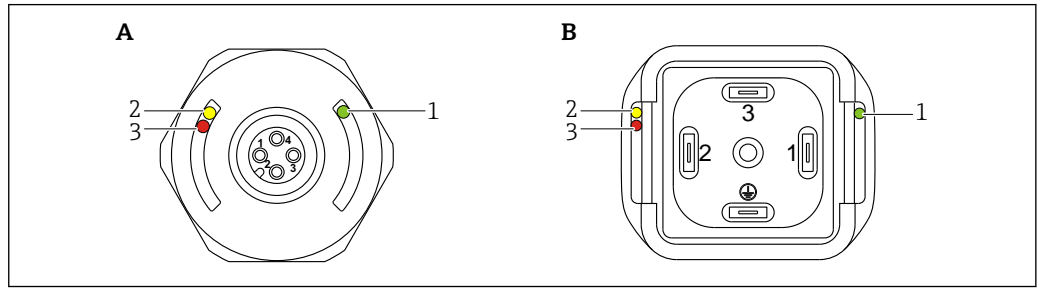

A M12 connector, (cable without graphic)
 B Valve plug



Item	Function	Description
1	Green LED (gn) Lit	Device is operational
2	Yellow LED (ye) Lit	M12 connector Indicates the sensor state: tuning fork is covered by liquid Valve plug / cable Indicates the switching state: <ul style="list-style-type: none"> ▪ MAX operating mode (overflow prevention): sensor is not covered by liquid ▪ MIN operating mode (dry running protection): the sensor is covered by liquid
3	Red LED (rd) Flashing Lit	Warning/maintenance required: Fault can be remedied, e.g. incorrect wiring; protective function if test magnet is held against the sensor for longer than 30 s Fault/device failure: error cannot be rectified, e.g. electronic error

Function test with test magnet

Carry out a function test while the device is in operation.

- ▶ Hold the test magnet against the marking on the housing for at least 2 seconds.
 - ↳ This inverts the current switch status, and the yellow LED changes state. When the magnet is removed, the switching status valid at that time is adopted.

If the test magnet is held against the marking for longer than 30 seconds, the red LED will flash: The device returns automatically to the current switch status.

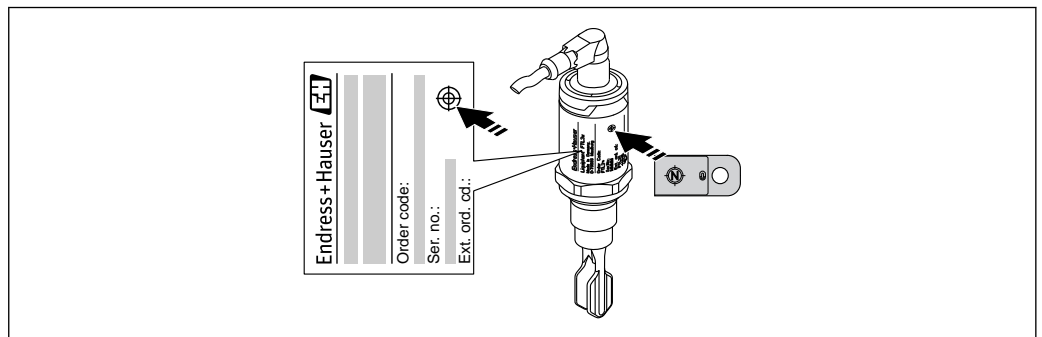

 The test magnet is not included in the scope of delivery. It can be ordered as an optional accessory →  27.



 17 Position for test magnet on housing

Certificates and approvals

 The following documents are also available in the Download Area of the Endress+Hauser website: www.endress.com → Downloads.

CE mark	The measuring system is in conformity with the statutory requirements of the applicable EC Directives. These are listed in the corresponding EC Declaration of Conformity along with the standards applied. Endress+Hauser confirms successful testing of the device by affixing to it the CE mark.
EAC conformity	The measuring system meets the legal requirements of the applicable EAC guidelines. These are listed in the corresponding EAC Declaration of Conformity together with the standards applied. Endress+Hauser confirms successful testing of the device by affixing to it the EAC mark.
RCM-Tick marking	The supplied product or measuring system meets the ACMA (Australian Communications and Media Authority) requirements for network integrity, interoperability, performance characteristics as well as health and safety regulations. Here, especially the regulatory arrangements for electromagnetic compatibility are met. The products are labelled with the RCM- Tick marking on the name plate.  <small>A0029561</small>
Approval	CSA C/US General Purpose
Overfill prevention	 Prior to mounting the device, pay attention to the WHG approval documents which can be found on the Endress+Hauser web site: www.endress.com → Downloads. WHG <ul style="list-style-type: none"> ▪ Overfill detection system: Z-65.11-531 ▪ Leak detection system: Z-65.40-532
Marine approvals	<ul style="list-style-type: none"> ▪ GL (German Lloyd) ▪ ABS (American Bureau of Shipping) ▪ LR (Lloyds Register) ▪ BV (Bureau Veritas) ▪ DNV (Det Norske Veritas)
CRN approval	Versions with a CRN approval (Canadian Registration Number) are listed in the corresponding registration documents. CRN-approved devices are labeled with registration number OF16950.5C on the nameplate. You can find further details on the maximum pressure values in the Download Area of the Endress+Hauser website.
Inspection certificates	The following documents can be ordered with the device (optional): <ul style="list-style-type: none"> ▪ Acceptance test certificate as per EN 10204-3.1 ▪ Final inspection report
Manufacturer declarations	The following manufacturer declarations can be ordered (optional): <ul style="list-style-type: none"> ▪ FDA conformity ▪ TSE-free, materials free from animal origin ▪ ROHS-compliant in accordance with Endress+Hauser regulation
Pressure Equipment Directive	The device does not fall within the scope of Pressure Equipment Directive 97/23/EC as it does not have a pressurized housing as defined in Article 1, Section 2.1.4 of the directive.
Other standards and guidelines	The applicable European guidelines and standards can be found in the relevant EU Declarations of Conformity.

Ordering information

Ordering information

Detailed ordering information is available from the following sources:

- In the Product Configurator on the Endress+Hauser website: www.endress.com -> Click "Corporate" -> Select your country -> Click "Products" -> Select the product using the filters and search field -> Open product page -> The "Configure" button to the right of the product image opens the Product Configurator.
- From your Endress+Hauser Sales Center: www.addresses.endress.com

 Product Configurator - the tool for individual product configuration

- Up-to-the-minute configuration data
- Depending on the device: Direct input of measuring point-specific information such as measuring range or operating language
- Automatic verification of exclusion criteria
- Automatic creation of the order code and its breakdown in PDF or Excel output format
- Ability to order directly in the Endress+Hauser Online Shop

Services (optional)

In addition, the following services can be selected via the product structure in the Product Configurator:

- Cleaned of oil+grease
- PWIS-free (PWIS = paint-wetting impairment substances)
- Density setting > 0.5 g/cm³
- Switching delay setting →  11

Accessories



Weld-in adapter

Various weld-in adapters are available for installation in vessels or pipes.

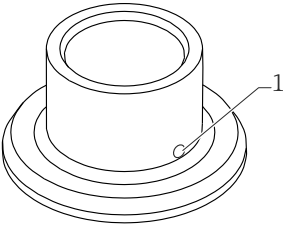
- ** The adapters are optionally available with inspection certificate 3.1 EN10204.

View (example)	Description
 <p style="text-align: right; margin-right: 50px;">A0023557</p> <p>1 Leakage hole</p>	<p>G ¾" ø29 pipe installation ø50 vessel installation FDA-listed materials as per 21 CFR Part 175-178</p>
	<p>G 1" ø53 pipe installation ø60 vessel installation</p>

If installed horizontally and weld-in adapters with a leakage hole are used, ensure that the leakage hole is pointing down. This allows leaks to be detected as quickly as possible.

- ** Detailed information can be found in TI00426F/00/EN "Weld-in adapters, process adapters and flanges" and in the supplementary documentation →  29.

Plug-in jack, cable

- ** The plug-in jacks listed are suitable for use in the temperature range -25 to +70 °C (-13 to +158 °F).

Engineering unit mm (in)

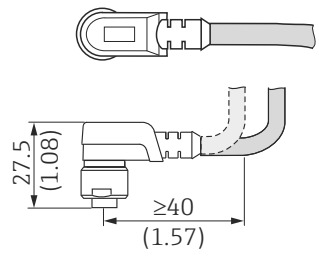
Plug-in jack M12 IP67	Description	Order number
	<ul style="list-style-type: none"> elbowed 90° 5 m (16 ft) PVC cable (gray) Slotted nut Cu Sn/Ni Body: PUR (blue) 	52010285

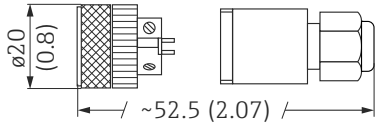
Plug-in jack M12 IP67	Description	Order number
	<ul style="list-style-type: none"> Self-terminated connection to M12 connector Slotted nut Cu Sn/Ni Body: PBT 	52006263

Wire colors for M12 connector: 1 = BN (brown), 2 = WT (white), 3 = BU (blue), 4 = BK (black)

Additional accessories

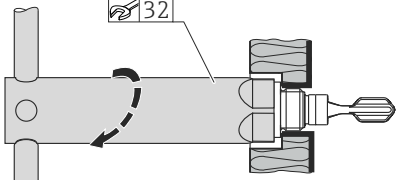
Socket wrench for mounting	Description	Order number
	<ul style="list-style-type: none"> Hexagonal Size across flats AF32 	52010156

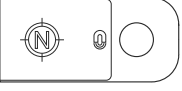
Test magnet	Description	Order number
	Information in section on Operation → 25	71267011

Supplementary documentation



The following document types are available in the Download Area of the Endress+Hauser website: www.endress.com → Downloads.

Operating Instructions

Liquiphant FTL31 → BA01285F/00

Additional documentation

TI00426F/00 → Weld-in adapters, process adapters and flanges (overview)

SD01622Z/00 → Weld-in adapter (installation instructions)

SD00356F/00 → Valve plug (installation instructions)

Certificates

ZE01010F/00 → Overfill protection

ZE01011F/00 → Leaks



www.addresses.endress.com
